



Commission for
Communications Regulation

Report

Programme of Measurement of Non-Ionising Radiation emissions

0450R - Sutton Cross

Site Measurement Date:

1st April 2004.

Contents

1	Introduction	3
2	Background	4
2.1	ROLE OF THE COMMISSION FOR COMMUNICATIONS REGULATION	4
2.2	ROLE OF MASON COMMUNICATIONS LTD.	4
3	NIR Site Measurements Conclusion and Results	5
3.1	CONCLUSION OF SITE REPORT RESULTS	7
3.2	SITE REPORT – SUTTON CROSS	8
3.2.1	<i>Detailed Results</i>	8
3.2.2	<i>SITE SKETCH MAP</i>	14
3.2.3	<i>SITE PHOTOGRAPHS</i>	15
	Annex 1	16
	Annex 2	19
	Glossary.....	21

1 Introduction

The Commission for Communications Regulation (ComReg) is the licensing authority for the use of the radio frequency spectrum in Ireland. This spectrum is a national resource which has been used for communications purposes for over 100 years. Applications of radio spectrum, today, include the transmission of a wide range of services, including radio and television broadcasting, mobile telephony and other telecommunications services such as internet connection.

As the licensing authority for radiocommunications in Ireland, ComReg is responsible for ensuring that communications operators comply with their licence condition relating to non-ionising radiation. The radiation emissions from communications sites must be within the levels set down in the latest international guidelines.

The full programme consists of the measurement of Non-Ionising Radiation emissions at 400 sites throughout the country. The programme is being carried out by Mason Communications in conjunction with Radio Frequency Investigations on behalf of ComReg.

For each site, ComReg requires that the measured levels of non-ionising radiation emissions should not exceed the ICNIRP limits in any part of the site or surrounding area where the general public have access. Non-ionising radiation is that part of the electromagnetic spectrum below 2420 million MHz. Radiowaves, infra-red radiation and visible light are examples of NIR.(See Annex 1)

This report is arranged as follows:

The first section is an introduction to the programme.

The second section outlines the role of the ComReg in the area of NIR. It also outlines Mason Communications role in the programme.

The third section is Mason Communications' report on the measurement programme for the site. The site report contains a conclusion on the extent of compliance of the site with the general public exposure limits of the ICNIRP Guidelines 1998.

The Annex section contains two sections which are as follows:

1. An explanation of Non-Ionising Radiation and an explanation of the International Committee for Non-Ionising Radiation Protection and the guideline limits associated with that body.
2. A guide to the methodology used in the site measurements.

There is also a glossary explaining each of the terms used through the report.

2 Background

2.1 Role of the Commission for Communications Regulation

In 2003/2004 measurements of Non-Ionising Radiation emissions are being taken at 400 sites throughout the country in a programme agreed with the Minister for Communications, Marine and Natural Resources, and the Minister for the Environment and Local Government. The programme is being carried out by Mason Communications in conjunction with Radio Frequency Investigations (RFI) on behalf of ComReg.

The aim of the programme is to ensure that emissions from communications sites comply with the general public exposure limits set down by the International Commission for Non-Ionising Radiation Protection (ICNIRP). Some sites have been nominated by the public and the other sites are chosen by Mason/RFI, based on population coverage. Currently, radiation emissions from communications sites must be within the levels set down in the ICNIRP guidelines.

At the outset of the programme, ComReg invited nominations from the interested parties for telecommunication masts to be included. The last date for nominations was 6th June 2003 and on this date some thirty sites had been nominated by the public and 25 by the Minister's department. The other sites were chosen on a random basis by Mason/RFI. Both methods of choosing sites were based on population distribution.

2.2 Role of Mason Communications Ltd.

Following a competitive tender process held in early 2003, Mason Communications in conjunction with Radio Frequency Investigations Ltd. were chosen to carry out the site measurements and to produce a report on each site. Mason Communications Ireland Ltd. is a wholly owned subsidiary of Mason Group Ltd. Mason advises many of the leading organisations in Ireland on converging markets and converging technologies. The management of this programme by Mason Communications involved the services of Radio Frequency Investigations (RFI) Ltd. RFI has been performing Non-Ionising Radiation site surveys since its formation in 1987. RFI is accredited to ISO 17025, which ensures independence from other bodies that may be involved directly or indirectly in this programme.

3 NIR Site Measurements Conclusion and Results

ComReg has commissioned Mason Communications, as an independent consultancy service, to conduct a survey of 400 sites. Mason Communications and their measuring sub-contractor “Radio Frequency Investigation (RFI) Ltd” will work on the programme throughout 2003 and 2004.

Mason/RFI engineers measure the power density of transmissions in the various radio bands to be surveyed¹. The results, derived from electric field voltage measurements, are referenced to and presented alongside the relevant International Commission on Non-Ionising Radiation Protection (ICNIRP) recommended public maximum exposure levels.

Section 3.2 provides a set of graphs and tables for each location where measurements were made.

At each location electric field strength measurements, conducted in the frequency bands of interest, are recorded and converted to power density levels for direct comparison with the ICNIRP guideline levels. These power density levels are tabulated alongside the relevant ICNIRP limits. The tables present the highest emission level readings recorded within a band. To the left of each of the results tables, a graphical snapshot of the radio spectrum being analysed is presented.

The power density and the quotient contained in these graphs are given in exponential (E) format. The reason for this is that the value is too long to be represented as a decimal number in the tables. An example of this is as follows:

$$3.61469\text{E-}09 = 3.61469 \times 10^{-9} = .00000000361469$$

It is therefore very important to note the values after E to identify the highest reading at any site. For each table at each position the highest reading is at the top of the relevant list.

¹ See Annex 2 for the site measurement methodology

**Site Survey Report from
Mason Communications Ltd /
Radio Frequency Investigation Ltd**

Audit Site: DF14 – Sutton Cross

	NAME	SIGNATURE	DATE
PREPARED BY	S. Roe		14 th April 2004
REVIEWED BY	P. Kidney		14 th April 2004
SIGNED-OFF BY	P. Coakley		14 th April 2004
This report has been reviewed by Mason Communications and accurately reflects the measurements taken at Sutton Cross by Dan Smith on 1 st April 2004.			

3.1 Conclusion of site report results

The following table is a summary of the highest readings taken at this site:

Site	Frequency Range	Highest reading W/m ²	ICNIRP guideline Limit W/m ²
Sutton Cross	300MHz – 1GHz	0.000681803	4.825
	GSM 900	0.000492786	4.79665
	GSM 1800	0.000673998	9.365
	1GHz – 2GHz	0.000459895	9.4

The overall measurements taken at the site and given in part 3.2 of this report conclude that the NIR emissions from the site are below the ICNIRP guideline limits.

3.2 Site Report – Sutton Cross

3.2.1 Detailed Results

3.2.1.1 Position 1. Sutton Cross, Marine Hotel, in Front Car Park, approximately 75 m North of Antennas.

Site: Sutton Cross	Receiver: Manufacturer: Hewlett Packard Model: 8594A Serial Number: 3108U00205
Location: Position 1	Antenna: Manufacturer: EMCO Model: 3146A Serial Number: 3993
NGR: O 25744 39305	
Date: 01/04/04	
Officer: Dan Smith	

300 MHz to 1 GHz					
<p>45019_DF14_01 - Sutton Cross 001</p> <p>Ambient Emissions</p> <p>Start 300.0 MHz; Stop 1.0 GHz Ref 117 dBµV; Ref Offset 0.0 dB; 10 dB/div RBW 300.0 kHz; VBW 300.0 kHz; Att 0 dB; Swp 0.0 pS Peak 965.0 MHz; 114.1 dBµV Transducer Factors: log periodic 01/04/2004 13:00:11</p>	Frequency (MHz)	S (power density) W/m ²	ICNIRP Limit W/m ²	Times less than ICNIRP	Quotient
	965	0.000681803	4.825	7076.828449	0.000141306
	916	0.000001267	4.58	3615820.213	2.76562E-07
	748	0.000000562	3.74	6655994.469	1.50241E-07
	587	0.000000488	2.935	6011037.755	1.66361E-07
	538	0.000000270	2.69	9979151.827	1.00209E-07
	571.3	0.000000198	2.8565	14460242.58	6.91551E-08
	779.5	0.000000169	3.8975	23021174.35	4.34383E-08
	753.3	0.000000144	3.7665	26078302.7	3.83461E-08
	804	0.000000140	4.02	28811601.76	3.47082E-08
			Total Quotient	0.000142185	

GSM 900					
<p>45019_DF14_01 - Sutton Cross 002</p> <p>GSM 900 Downlink</p> <p>Start 924.0 MHz; Stop 961.0 MHz Ref 117 dBµV; Ref Offset 0.0 dB; 1.0 dB/div RBW 300.0 kHz; VBW 300.0 kHz; Att 0 dB; Swp 0.0 pS Peak 959.33 MHz; 112.69 dBµV Transducer Factors: log periodic 01/04/2004 13:04:34</p>	Frequency (MHz)	S (power density) W/m ²	ICNIRP Limit W/m ²	Times less than ICNIRP	Quotient
	959.33	0.000492786	4.79665	9733.731906	0.000102736
	955.36	0.000124640	4.7768	38324.66862	2.60929E-05
	951.01	0.000010731	4.75505	443094.5805	2.25685E-06
	949.99	0.000007476	4.74995	635375.3885	1.57387E-06
	947.31	0.000001139	4.73655	4157224.484	2.40545E-07
	944.63	0.000000280	4.72315	16887800.45	5.92143E-08
			Total Quotient	0.000132959	

Site: Sutton Cross	Receiver: Manufacturer: Hewlett Packard Model: 8594A Serial Number: 3108U00205
Location: Position 1	Antenna: Manufacturer: EMCO Model: 3115 Serial Number: 1203
NGR: O 25744 39305	
Date: 01/04/04	
Officer: Dan Smith	

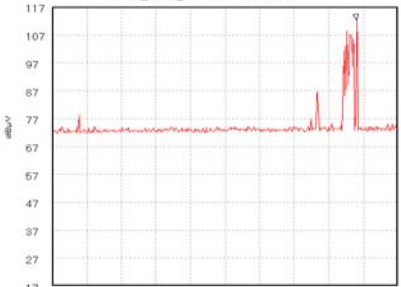
1GHz to 2 GHz					
 <p>45019_DF14_01 - Sutton Cross 003</p> <p>Start 1.0 GHz; Stop 2.0 GHz Ref 117 dBµV; Ref Offset 0.0 dB; 10 dB/dv RBW 300.0 kHz; VBW 300.0 kHz; Att 0 dB; Swp 0.0 pS Peak 1.88 GHz; 112.39 dBµV Transducer Factors: 1 to 18 Horn 01/04/2004 13:10:46</p>	Frequency (GHz)	S (power density) W/m ²	ICNIRP Limit W/m ²	Times less than ICNIRP	Quotient
	1.88	0.000459895	9.4	20439.44993	4.8925E-05
	1.853	0.000179332	9.265	51663.85085	1.93559E-05
	1.863	0.000137613	9.315	67689.95252	1.47732E-05
	1.87	0.000093683	9.35	99805.15216	1.00195E-05
	1.848	0.000052440	9.24	176203.0094	5.67527E-06
	1.843	0.000036279	9.215	254001.7389	3.93698E-06
	1.768	0.000001204	8.84	7341648.965	1.36209E-07
	1.078	0.000000178	5.39	30264263.91	3.30423E-08
				Total Quotient	0.000102855

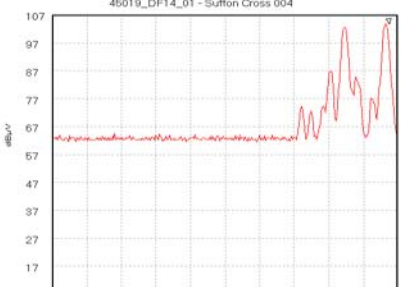
1805-1842 MHz					
 <p>45019_DF14_01 - Sutton Cross 004</p> <p>Start 1.804 GHz; Stop 1.843 GHz Ref 107 dBµV; Ref Offset 0.0 dB; 10 dB/dv RBW 300.0 kHz; VBW 300.0 kHz; Att 0 dB; Swp 0.0 pS Peak 1.842 GHz; 105.9 dBµV Transducer Factors: 1 to 18 Horn 01/04/2004 13:13:05</p>	Frequency (GHz)	S (power density) W/m ²	ICNIRP Limit W/m ²	Times less than ICNIRP	Quotient
	1.842	0.000063630	9.21	144744.1367	6.90874E-06
	1.837	0.000048268	9.185	190291.9913	5.25508E-06
	1.835	0.000001255	9.175	7310505.752	1.36789E-07
	1.838	0.000000837	9.19	10981378.52	9.10632E-08
	1.84	0.000000139	9.2	66088999.54	1.51311E-08
	1.832	0.000000071	9.16	128303003.7	7.79405E-09
	1.833	0.000000049	9.165	188136828.9	5.31528E-09
			Total Quotient	1.24199E-05	

Site: Sutton Cross	Receiver: Manufacturer: Hewlett Packard Model: 8594A Serial Number 3108U00205
Location: Position 1	Antenna: Manufacturer: EMCO Model: 3115 Serial Number: 1203
NGR: O 25744 39305	
Date: 01/04/04	
Officer: Dan Smith	

1843 – 1880MHz					
<p>45019_DF14_01 - Sutton Cross 005</p> <p>Start 1.842 GHz; Stop 1.881 GHz Ref 117 dBµV; Ref Offset 0.0 dB; 10 dBkV RBW 300.0 kHz; VBW 300.0 kHz; Att 0 dB; Swp 0.0 pS Peak 1.873 GHz, 114.05 dBµV Transducer Factors: 1 to 18 Horn 01/04/2004 13:21:12</p>	Frequency (GHz)	S (power density) W/m ²	ICNIRP Limit W/m ²	Times less than ICNIRP	Quotient
	1.873	0.000673998	9.365	13894.69864	7.197E-05
	1.846	0.000156192	9.23	59093.9542	1.6922E-05
	1.864	0.000101311	9.32	91993.52545	1.087E-05
	1.866	0.000082160	9.33	113559.3751	8.806E-06
	1.853	0.000069288	9.265	133717.046	7.4785E-06
	1.856	0.000020733	9.28	447599.2255	2.2341E-06
	1.857	0.000017851	9.285	520143.5989	1.9225E-06
	1.861	0.000015836	9.305	587567.4485	1.7019E-06
	1.854	0.000014049	9.27	659813.3287	1.5156E-06
				Total Quotient	0.00012342

3.2.1.2 Position 2. Sutton Cross, At Cross Roads, Outside EBS Building Society, approximately 75 m North East of Antennas.

Site: Sutton Cross	Receiver: Manufacturer: Hewlett Packard Model: 8594A Serial Number: 3108U00205
Location: Position 2	
NGR: O 25817 39317	Antenna: Manufacturer: EMCO Model: 3146A Serial Number: 3993
Date: 01/04/04	
Officer: Dan Smith	

300 MHz to 1 GHz					
	Frequency (MHz)	S (power density) W/m ²	ICNIRP Limit W/m ²	Times less than ICNIRP	Quotient
	958	0.000175250	4.79	27332.34309	3.65867E-05
	914.2	0.000002677	4.571	1707467.993	5.85663E-07
	949.2	0.000000292	4.746	16280550.44	6.1423E-08
	454	0.000000165	2.27	13720413.73	7.28841E-08
	392.8	0.000000162	1.964	12091573.88	8.27022E-08
	804	0.000000159	4.02	25326046.7	3.9485E-08
	779.5	0.000000114	3.8975	34050812.09	2.93679E-08
	748	0.000000108	3.74	34610904.77	2.88926E-08
	571.3	0.000000071	2.8565	40473948.86	2.47073E-08
			Total Quotient	3.75118E-05	

GSM 900					
	Frequency (MHz)	S (power density) W/m ²	ICNIRP Limit W/m ²	Times less than ICNIRP	Quotient
	954.62	0.000183510	4.7731	26010.09171	3.84466E-05
	953.41	0.000166978	4.76705	28549.0103	3.50275E-05
	958.87	0.000160568	4.79435	29858.71309	3.34911E-05
	956.28	0.000119580	4.7814	39984.93804	2.50094E-05
	951.19	0.000001913	4.75595	2486443.702	4.02181E-07
	949.99	0.000001201	4.74995	3953942.855	2.52912E-07
	947.31	0.000000588	4.73655	8050140.799	1.24221E-07
	944.72	0.000000509	4.7236	9281420.822	1.07742E-07
			Total Quotient	0.000132862	

Site: Sutton Cross	Receiver: Manufacturer: Hewlett Packard Model: 8594A Serial Number: 3108U00205
Location: Position 2	Antenna: Manufacturer: EMCO Model: 3115 Serial Number: 1203
NGR: O 25817 39317	
Date: 01/04/04	
Officer: Dan Smith	

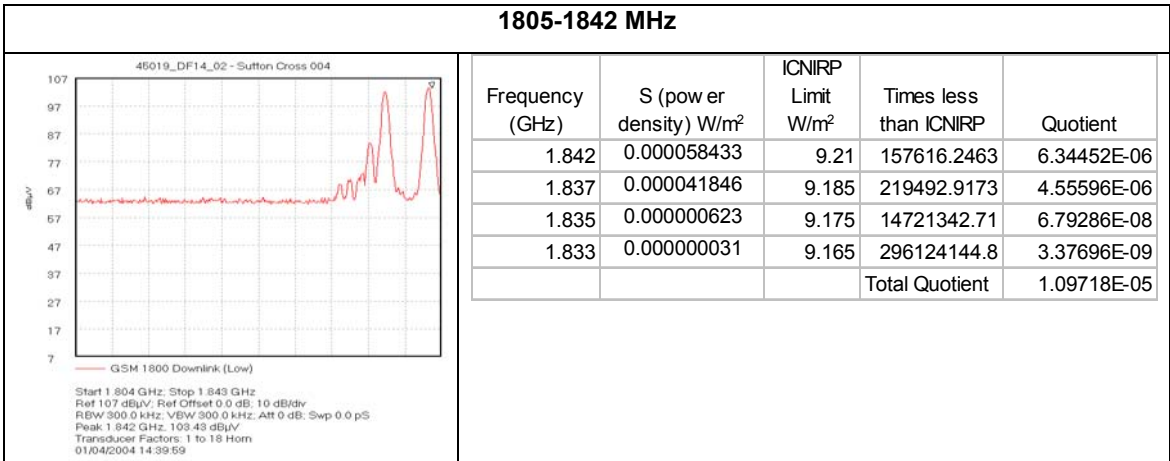
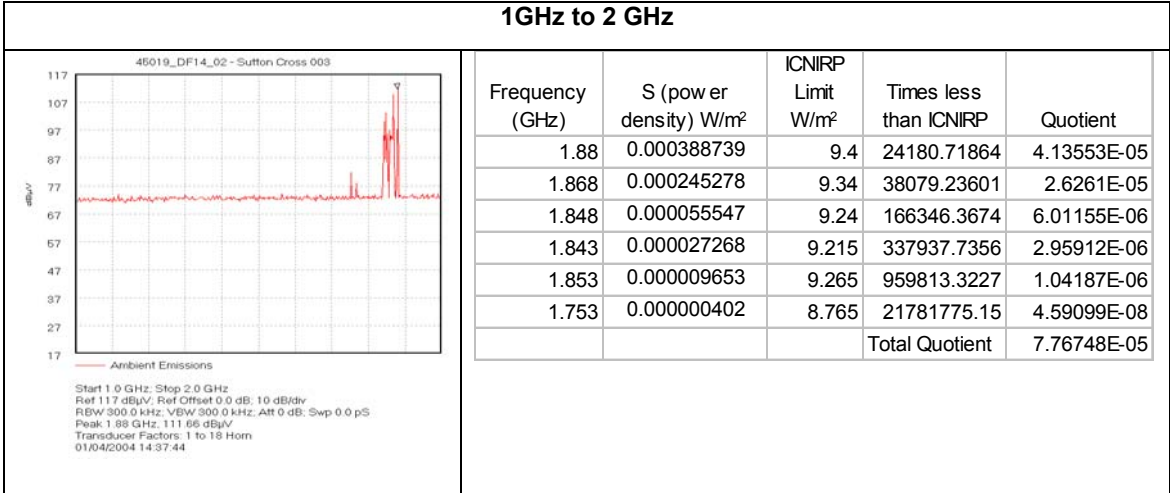

Site: Sutton Cross	Receiver: Manufacturer: Hewlett Packard Model: 8594A Serial Number: 3108U00205
Location: Position 2	Antenna: Manufacturer: EMCO Model: 3115 Serial Number: 1203
NGR: O 25817 39317	
Date: 01/04/04	
Officer: Dan Smith	

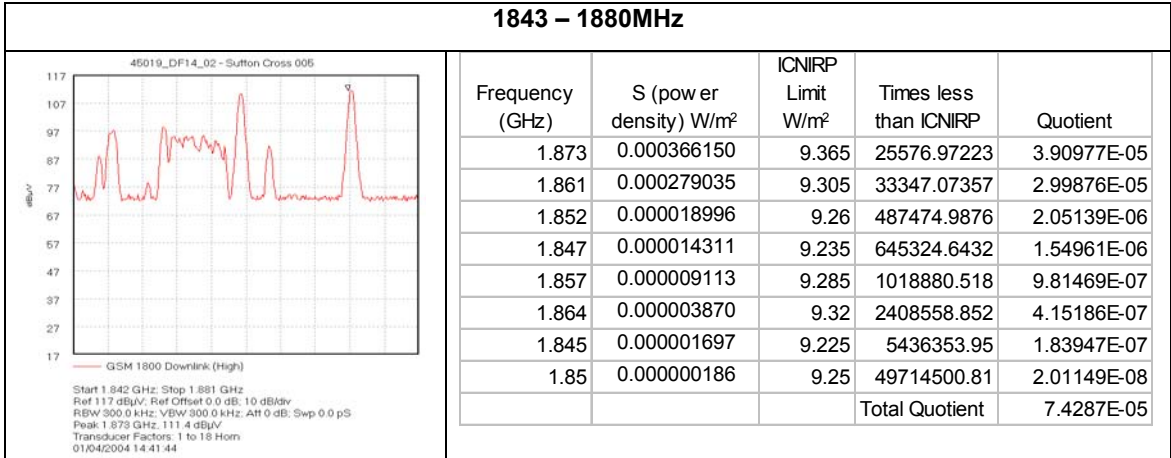

3.2.2 SITE SKETCH MAP

Position 1 Sutton Cross, Marine Hotel, in Front Car Park, approximately 75 m North of Antennas. (See Mark 01)

Position 2. Sutton Cross, At Cross Roads, Outside EBS Building Society, approximately 75 m North East of Antennas. (See Mark 02)

RADIO FREQUENCY INVESTIGATION LTD

OFF-SITE WORKBOOK
Test No. 45019

For: Mason Communications
Survey Of:
Location:

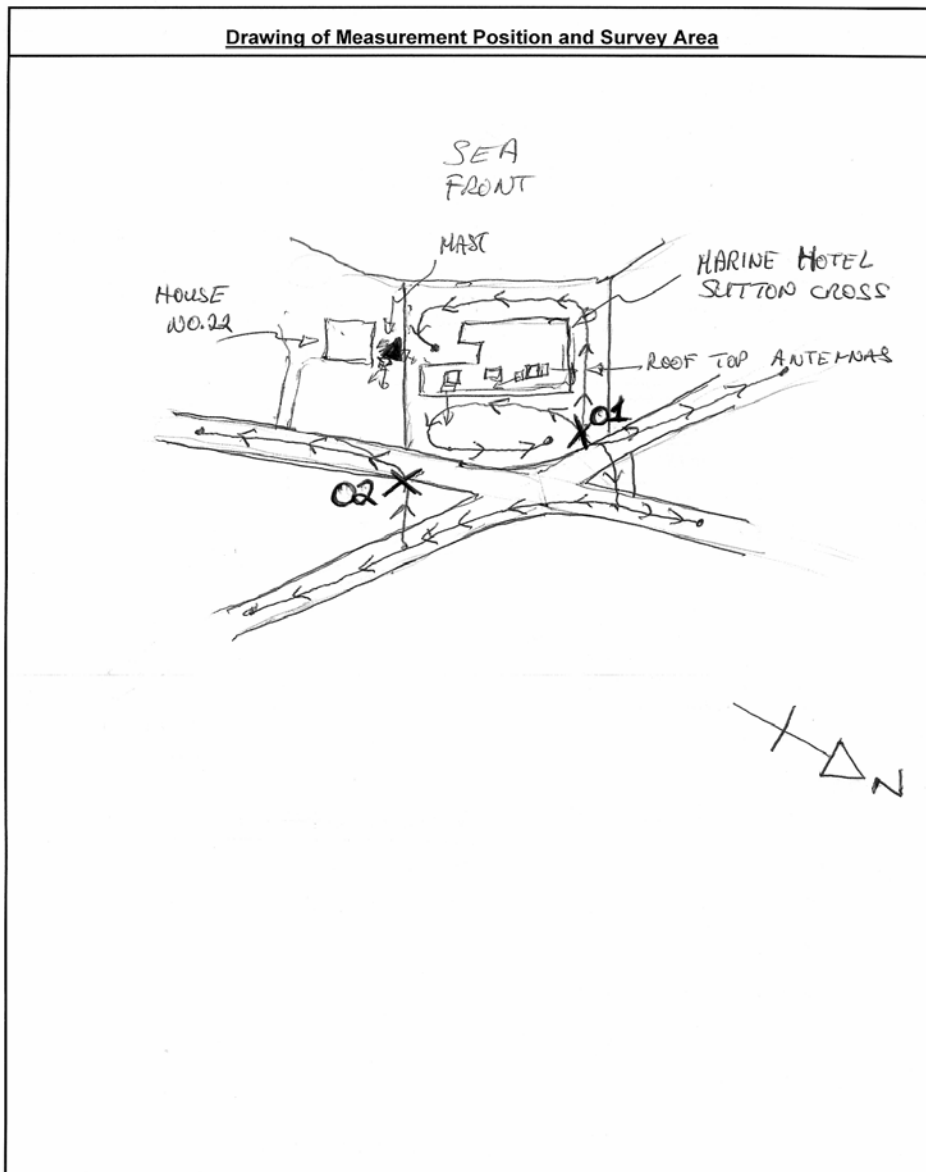

3.2.3 SITE PHOTOGRAPHS

3.2.3.1 Position 1. Sutton Cross, Marine Hotel, in Front Car Park, approximately 75 m North of Antennas.



3.2.3.2 Position 2. Sutton Cross, At Cross Roads, Outside EBS Building Society, approximately 75 m North East of Antennas.

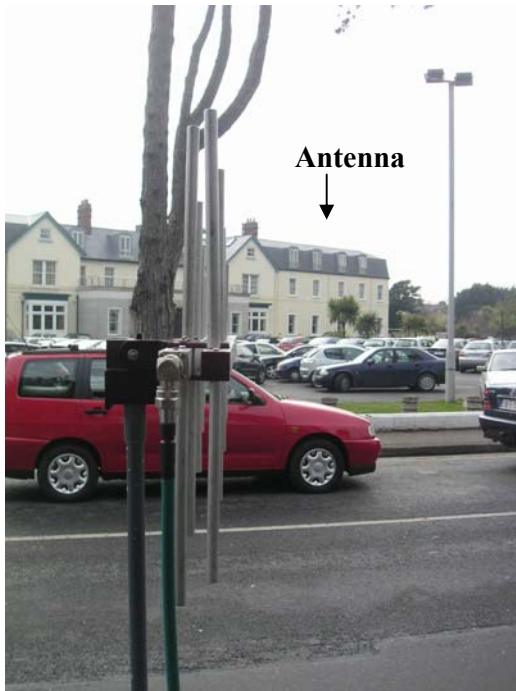

Annex 1

Non-Ionising Radiation (NIR) and the International Commission for Non-Ionising Radiation Protection (ICNIRP)

Non-ionising Radiation (NIR) Definition

Non-ionising radiation is that part of the electromagnetic spectrum below 2420 million MHz. Radiowaves, infra-red radiation and visible light are examples of NIR. Electromagnetic waves at frequencies above 2420 million MHz (2.4THz) are known as ionising radiation and this includes X-rays and Gamma rays.

Standards for emissions limits for non-ionising radiation

The International Commission for Non-Ionising Radiation Protection (ICNIRP) is an independent, scientific organisation established in 1992. The ICNIRP was established for the purpose of advancing Non-Ionising Radiation Protection for the benefit of people and the environment and in particular to provide guidance and recommendations on protection from NIR exposure. ICNIRP operates in co-operation with the Environmental Health Division of the World Health Organisation and the United Nations Environment Programme. In 1998 ICNIRP issued a position paper on the health and safety aspects of NIR. This reviewed both thermal and athermal effects and its conclusion endorsed the 1988 guidelines produced by the IRPA.

This programme required sites to be in compliance with the ICNIRP (1998) guidelines. A summary of the maximum public exposure levels in the ICNIRP Guidelines for the radio systems in this audit are shown in Table 1. It should be noted that in 1999 the European Commission put out a recommendation² which proposed to limit exposure of the general public to electromagnetic fields 0 Hz-300 GHz based on a set of basic restrictions and reference levels developed internationally under the advice of the International Commission on Non-Ionising Radiation Protection. In relation to emissions within the radio spectrum, these limits are equivalent to the ICNIRP guideline limits used by the ODTR.

² Recommendation of the European Council 1999/519/EC of July 12, 1999

ICNIRP limits

In 1998 ICNIRP produced “Guideline for Limiting Exposure to Time-Varying Electric, Magnetic and Electromagnetic Fields (up to 300 GHz)”. ComReg and a large number of international regulators have adopted the 1998 ICNIRP document as the reference for ensuring that NIR levels do not cause an adverse health effect.

The main purpose of the “Guideline for Limiting Exposure to Time-Varying Electric, Magnetic and Electromagnetic Fields (up to 300 GHz)” is to provide guidelines for limiting Electromagnetic Field (EMF) exposure that will provide protection against known adverse health effects. An adverse health effect causes detectable impairment of the health of the exposed individual or his or her offspring.

Two classes of guidance are presented:

- Basic Restrictions
- Reference Levels

Basic Restrictions

Restrictions on exposure to time-varying electric, magnetic and electromagnetic fields that are based on health effects are termed “basic restrictions”. Depending upon the frequency of the field, the physical quantities used to specify these restrictions are current density (J), Specific Absorption Rate (SAR), and power density (S). However, only power density in air, outside the body, can be readily measured in exposed individuals.

Reference Levels

These levels are provided for practical exposure assessment purposes to determine whether the basic restrictions are likely to be exceeded. Some reference levels are derived from basic restrictions using measurement and/or computational techniques, and some address perception and adverse indirect effects of exposure to EMF.

Compliance with the reference levels will ensure compliance with the relevant basic restriction. If the measured or calculated value exceeds the reference level, it does not necessarily follow that the basic restriction will be exceeded. However, when a reference level is exceeded, it is necessary to test compliance with the relevant basic restriction and to determine whether additional protective measures are necessary.

The ICNIRP Guidelines: 1998 reference levels appropriate to the frequency range 100 kHz to 40GHz, covered by this report are given in the table:

FOR MEMBERS OF THE GENERAL PUBLIC

Frequency f (MHz)	Unperturbed RMS Electric Field Strength E(V/m)	Unperturbed RMS Magnetic Strength H(A/m)	Equivalent Plane Wave Power Density (mW/cm ²)	Radio Service
0.003-0.15	87	5	-	
0.15-1	87	0.73/f	-	LW and MW Radio Broadcasting
1-10	$87/f^{1/2}$	0.73/f	-	
10-400	28	0.073	0.2	VHF Radio and Television Broadcasting
400-2000	$1375f^{1/2}$	$0.0037xf^{1/2}$	f/200	UHF Television Broadcasting and Mobile Telephony Systems
2000-300000	61	0.16	1	Microwave Links, and MMDS

Note: “f” represents the frequency taken from the first column above

The guideline levels are lowest in the 10 MHz to 400 MHz frequency range as at these wavelengths resonance in parts or all of the body may occur resulting in optimum coupling of the radio frequency energy.

The ICNIRP guidelines require that in instances of simultaneous exposure to multiple sources, the sum of the exposure levels should be considered. In the case of the frequency range 30 MHz to 40 GHz, covered by the narrowband equipment used to generate this report, both the electric field strength and the magnetic field strength at each frequency should be expressed as a fraction of the limit at that frequency and both the sum of the electric field strength fractions squared and the sum of the magnetic field strength fractions squared should not exceed unity.

Annex 2

Methodology and measurements

Introduction

Measurements of the non-ionising radiation emissions from each site were conducted, in accordance with ECC Recommendation (02) 04. For the purposes of this programme, measurements were carried out at GSM sites and Mixed Use sites.

Cellular/GSM sites

Cellular/GSM Sites are sites and locations in Ireland at which electronic communications network transmission facilities and/or infrastructure are located, the primary purpose or sole use of such facilities/infrastructure being to facilitate the provision of mobile telephony services in Ireland.

Mixed use site

Mixed use sites are sites and locations in Ireland at which electronic communications network transmission facilities and/or infrastructure are located and where such facilities and or infrastructure is not primarily or solely used to facilitate the provision of mobile telephone services in Ireland.

Methodology

An initial survey of the area was conducted to determine the location(s) of highest non-ionising radiation emissions. At the GSM only site this was done by using a broadband probe and an engineering mobile phone, in conjunction with the appropriate software, to identify the position of maximum field strength. The engineering mobile phone provides an indication of the field strength levels from the GSM channels in use in the vicinity of the site.

Once the locations of the highest field strength emissions were identified, a series of narrowband measurements were taken at these locations. These measurements were taken using a spectrum analyser and associated antennas.

At GSM only sites, measurements were performed over the following frequency range from 300MHz – 2GHz. This range includes both the GSM900 and GSM1800 bands.

For mixed use sites, measurements were performed over the following frequency ranges 30MHz – 40GHz. These measurements included all radio services which are present at these

sites. These services include, GSM, Broadcasting, fixed links, MMDS, FWA. Point to Point links, amongst others.

At both GSM only sites and Mixed Use sites, electric field strength measurements conducted in the frequency bands of interest, are recorded and converted to power density levels for direct comparison with the ICNIRP guideline levels. These power density levels are tabulated alongside the relevant ICNIRP limits. The tables present the highest emission level readings recorded within a band.

Glossary

Antenna:

An antenna transmits energy to or receives energy from space.

Broadband Measurement:

Measurements carried out using a broadband probe measures the maximum power density at the site and compares it to the power density guideline limit in the ICNIRP guidelines. The probe reading is displayed as a percentage ratio of one to the other. In this project, the combined signal strengths of all radio transmissions in the area that is taken over the total range of frequencies between 100kHz to 40GHz is measured. The minimum sensitivity on the probe is 0.3% of the ICNIRP guideline limit, this means the probe will only pick up NIR levels when the level is equal to or greater than 1/3333 of the ICNIRP limit. As most measurements taken at sites using the probe are much less than 1/3333 of the ICNIRP limit, then the reading on the probe is generally zero.

Electric field strength:

This is a quantitative expression of the intensity of an electric field at a particular location. This is measured in volts per metre (V/m)

EMF:

Electric, magnetic, and electromagnetic fields.

Exposure:

This is the highest measured electric field strength converted to a power density equivalent.

Frequency:

The number of sinusoidal cycles completed by electromagnetic waves in 1 s; usually expressed in hertz (Hz).

Frequency Band:

A specific range of frequencies in the radio frequency spectrum, where each band has a defined upper and lower frequency limit.

ICNIRP:

International Commission for Non-Ionising Radiation Protection.

ICNIRP Limit:

This is the reference level, provided by the International Commission for Non-Ionising Radiation Protection (ICNIRP), for the maximum permitted non-ionising radiation emission levels for public exposure.

Reference Levels are frequency dependent and are currently defined as follows:

Frequency	ICNIRP Limit
10 – 400MHz	2W/m ²
400 MHz – 2GHz	((frequency in MHz)/200)W/m ²
2GHz – 300GHz	10 W/m ²

Narrowband Measurement:

Measurements carried out in specific frequency bands using a spectrum analyser and suitable antennas. The analyser is set up to measure one frequency band at a time to provide accurate readings over the particular range chosen.

Non-Ionizing Radiation (NIR):

Includes all radiations and fields of the electromagnetic spectrum that do not normally have sufficient energy to produce ionization in matter; characterized by energy per photon less than about 12 eV, wavelengths greater than 100 nm, and frequencies lower than 3×10^{15} Hz.

Power Density:

This is the radiant power incident perpendicular to a surface, divided by the area of the surface and is expressed in watts per square metre.

Quotient:

This is the ratio of the ICNIRP Limit to the maximum measured power density at a particular frequency. If the ratio is equal to or less than 1, then exposure levels are equal to or less than the ICNIRP Limits for the measured frequency.

Total Quotient:

This is the sum of the Quotients for a particular frequency band, or all measured bands, at the location of highest emissions at the site being measured.